

x 1

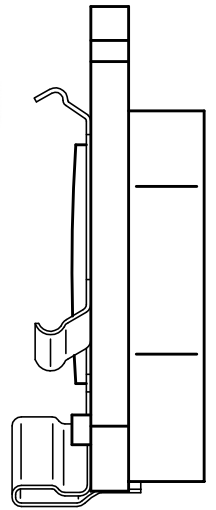

x 1

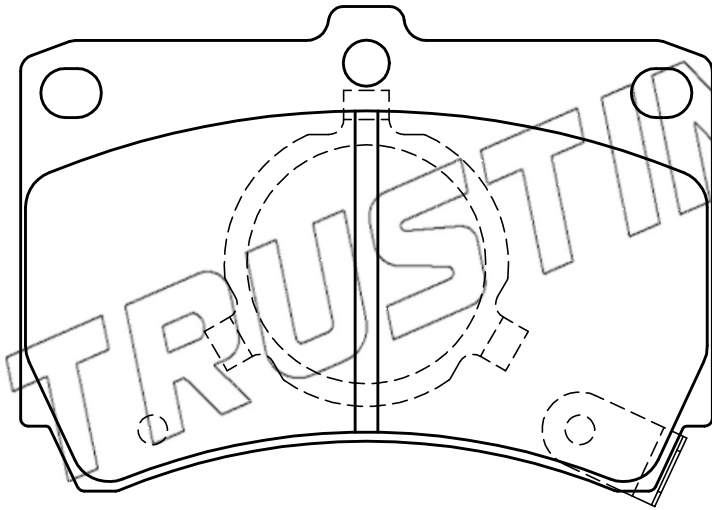
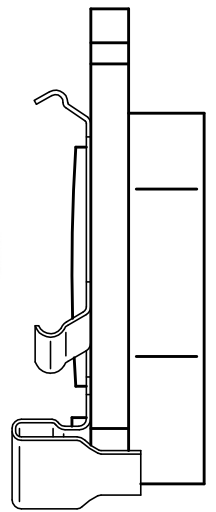
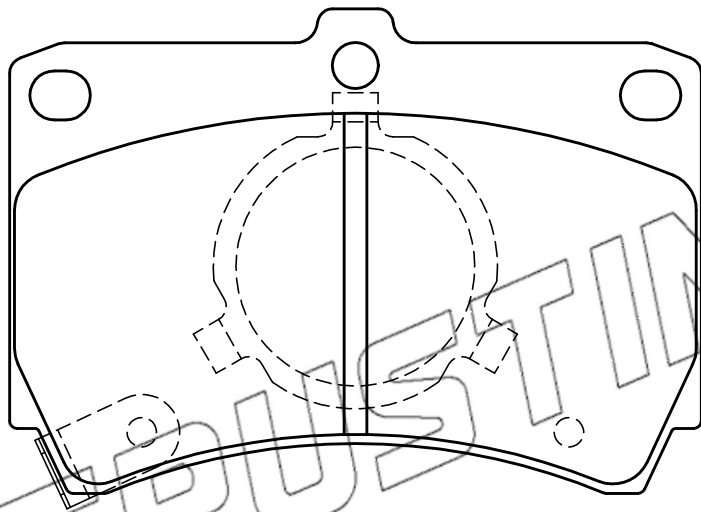

x 2

