

ATTENTION

Technical information 2009076

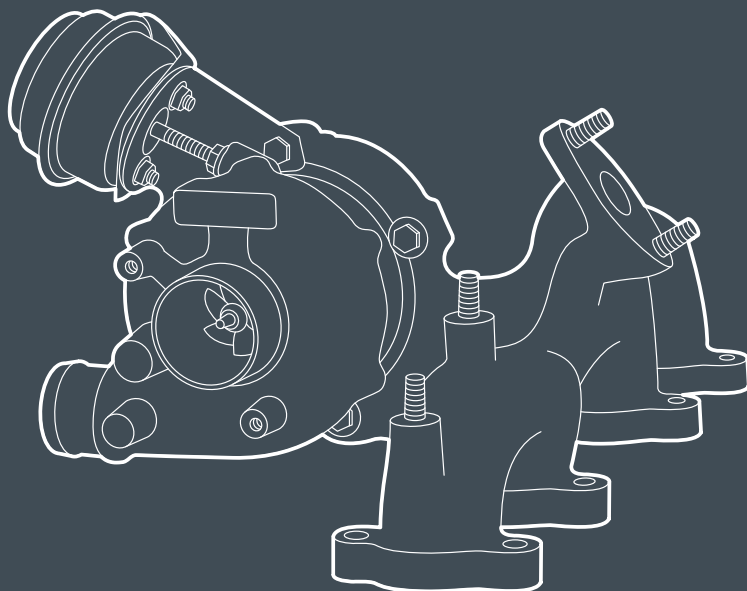

To ensure a long life of your new turbocharger, please follow the directions within this folder before mounting.



Um eine lange Lebensdauer Ihres neuen Turboladers zu gewährleisten, befolgen Sie bitte vor dem Einbau die Anweisungen in dieser Broschüre.



Læs venligst instruktionerne i denne folder før montering for at sikre et langt liv for din turbolader.



Pour assurer une longue durée de vie à votre nouveau turbocompresseur, veuillez suivre les instructions contenues dans ce dossier avant le montage.



Para garantizar una larga vida útil de su nuevo turbocompresor, siga las instrucciones de esta carpeta antes del montaje.



Per garantire una lunga durata del vostro nuovo turbocompressore, seguite le indicazioni all'interno di questa cartella prima del montaggio.



Para assegurar uma longa vida útil do seu novo turboalimentador, por favor siga as instruções dentro desta pasta antes de montar.



Aby zapewnić długą żywotność Twojej nowej turbosprężarki, proszę postępować zgodnie ze wskazówkami zawartymi w tym folderze przed montażem.



Abyste zajistili dlouhou životnost nového turbodmychadla, dodržujte před montáží pokyny uvedené v této složce.



Pentru a asigura o durată de viață lungă a noului turbocompresor, vă rugăm să urmați instrucțiunile din acest dosar înainte de montare.



Az új turbófeltöltő hosszú élettartamának biztosítása érdekében a felszerelés előtt kérjük, kövesse az ebben a mappában található utasításokat.



Da bi zagotovili dolgo življenjsko dobo novega turbinskega polnilnika, pred montažo upoštevajte navodila v tej mapi.

	Technical information 2009076	4
	Technische Informationen 2009076	5
	Teknisk information 2009076	6
	Informations techniques 2009076	7
	Boletín técnico 2009076	8
	Informazioni tecniche 2009076	9
	Informação técnica 2009076	10
	Informacje techniczne 2009076	11
	Technické informace 2009076	12
	Informații tehnice 2009076	13
	Műszaki információ 2009076	14
	Tehnične informácie 2009076	15



TECHNICAL DATA SHEET 2009076

Please pay special attention when positioning the gasket between the turbo and the exhaust manifold. As you can see in the photos below, there is a wrong way to positioning the gasket.

The improper positioning of the gasket prevents the turbo from operating under the parameters for which it was designed, as this hinders the entry of exhaust gases.



Wrong way



Wrong way

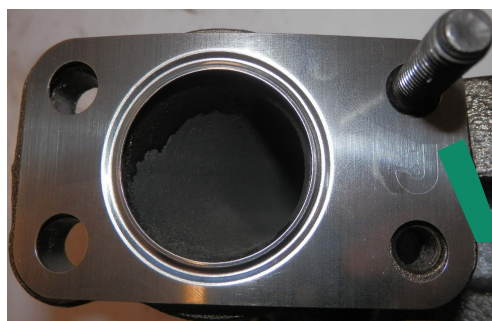

Right way

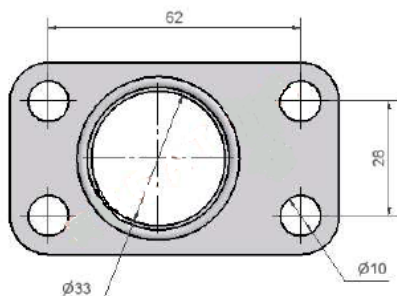

Dimensions of the gasket

TECHNISCHES MERKBLATT 2009076

Bitte seien Sie beim Einsetzen der Dichtung zwischen dem Turbo und dem Abgassammler besonders aufmerksam. Wie Sie auf den nachstehenden Fotografien erkennen können, kann die Dichtung falsch eingesetzt werden.

Eine falsche Anbringung der Dichtung hat zur Folge, dass der Turbo nicht unter den Parametern arbeitet, für die er konzipiert wurde, da die Dichtung in diesem Fall den Abgaseintritt behindert.



Falsch



Falsch

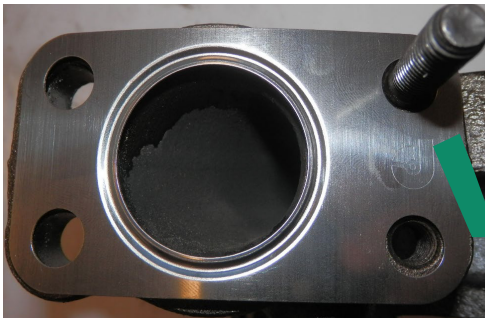

Richtig

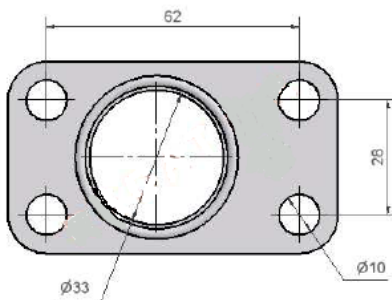

Maßangaben der Dichtung



TEKNISK DATABLAD 2009076

Vær særlig opmærksom, når du placerer pakningen mellem turboen og udstødningsmanifolden. Som du kan se på billederne nedenfor, er der en forkert måde at placere pakningen på.

Den forkerte placering af pakningen forhindrer turboen i at fungere under de parametre, som den er konstrueret til, da dette hindrer udstødningsgasserne i at trænge ind.



Forkert



Forkert

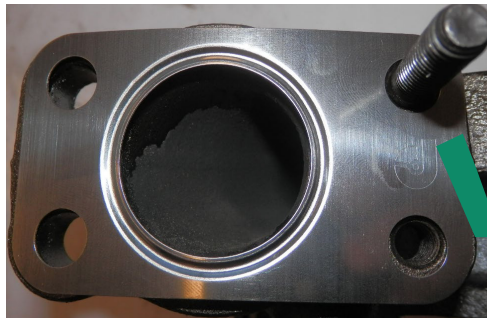

Korrekt

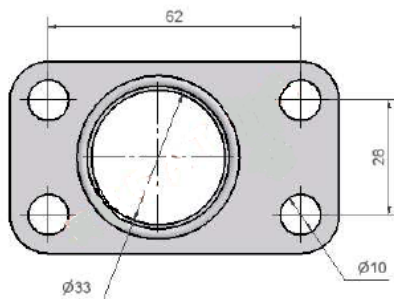

Mål for pakningen

FICHE TECHNIQUE 2009076

Nous vous prions d'accorder une attention tout particulière au moment de mettre en place le joint entre le turbo et le collecteur d'échappement. Comme vous pourrez le voir dans les photographies ci-dessous, il existe une manière incorrecte de mettre en place le joint.

Une mauvaise mise en place du joint fait que les performances du turbo ne répondent pas aux paramètres pour lesquels il a été conçu, car celui-ci entrave l'entrée des gaz d'échappement.



Mise en place incorrecte



Mise en place incorrecte

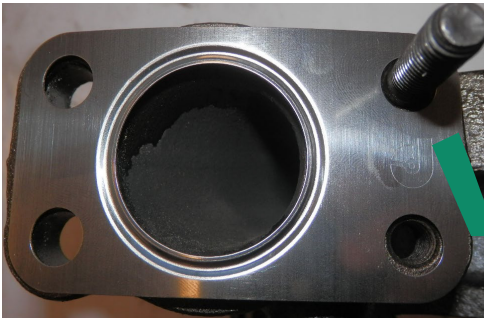

Mise en place correcte

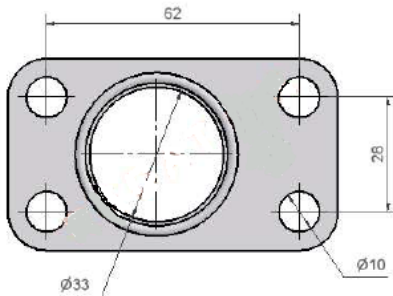

Cotes du joint



FICHA TÉCNICA 2009076

Les rogamos presten especial atención, a la hora de colocar la junta entre el turbo y el colector de escape. Como pueden apreciar en las fotografías inferiores, existe una forma incorrecta de colocar la junta.

La incorrecta colocación de la junta, provoca que el turbo no trabaje bajo los parámetros para los cuales fue diseñado, ya que esta entorpece la entrada de gases de escape.

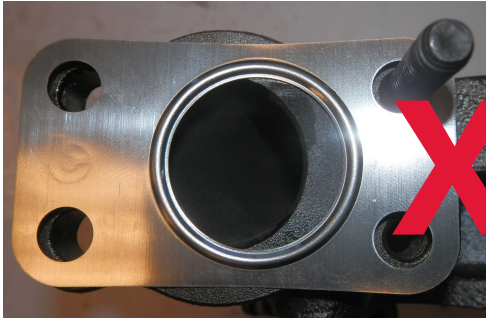

Forma incorrecta



Forma incorrecta

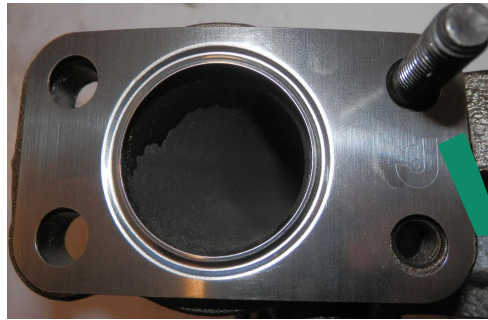

Forma correcta

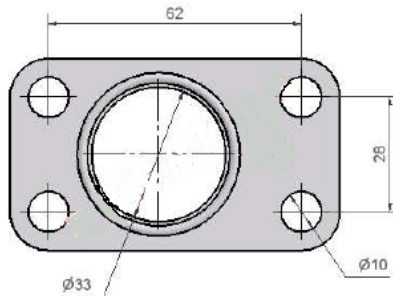

Cotas de la junta

SCHEMA TECNICA 2009076

Si prega di fare particolare attenzione, quando si posiziona la guarnizione fra il turbo e il collettore di scarico. Come si può notare dalle immagini seguenti, esiste un modo erraneo di posizionare la guarnizione.

Un posizionamento erraneo fa sì che il turbo non funzioni con i parametri per cui è stato pensato, dal momento che rallenta l'ingresso dei gas di scarico.

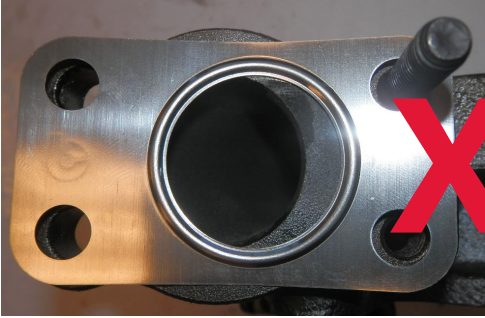

Modo erraneo



Modo erraneo



Modo corretto

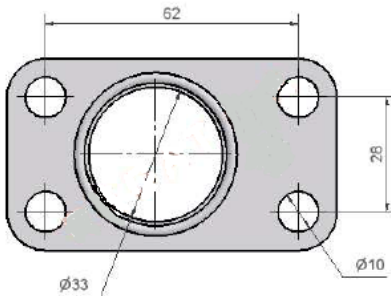

Quote della guarnizione



FICHA DE DADOS TÉCNICOS 2009076

Pedimos que prestem especial atenção ao colocar a junta entre o turbo e o coletor de escape. Como podem apreciar nas fotografias inferiores, há uma forma incorreta de colocar a junta.

A incorreta colocação da junta faz com que o turbo não trabalhe segundo os parâmetros para os quais foi concebido, visto entorpecer a entrada de gases de escape.

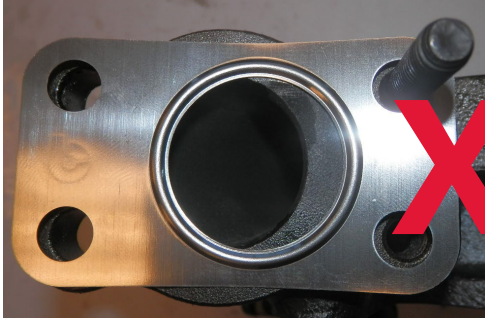

Forma incorreta



Forma incorreta

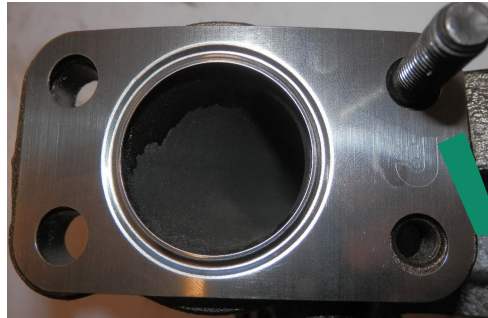

Forma correta

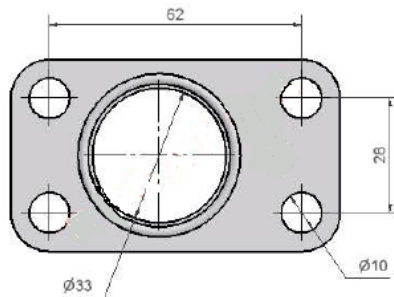

Cotas da junta

KARTA DANYCH TECHNICZNYCH 2009076

Należy zwrócić szczególną uwagę na ułożenie uszczelki pomiędzy turbo a kolektorem wydechowym. Jak widać na poniższych zdjęciach, istnieje niewłaściwy sposób pozycjonowania uszczelki.

Nieprawidłowe ułożenie uszczelki uniemożliwia pracę turbo zgodnie z parametrami, do których zostało zaprojektowane, ponieważ utrudnia to przedostawanie się spalin.



Niewłaściwa droga



Niewłaściwa droga

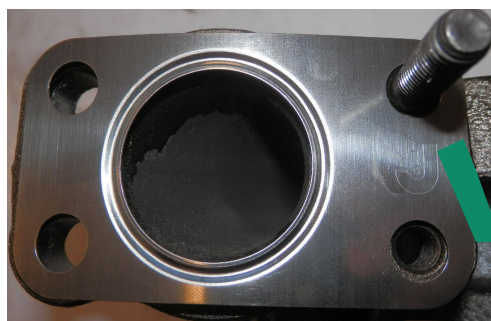

Właściwa droga

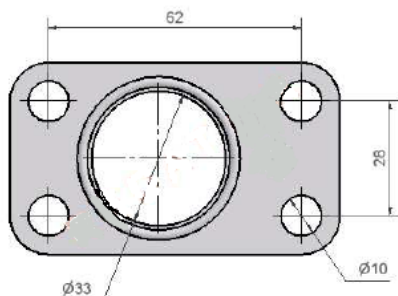

Wymiary uszczelki



TECHNICKÝ LIST 2009076

Budte prosím velmi obezřetní při umísťování těsnění mezi turbo a sběrač výfuku. Jak můžete vidět na těchto fotografiích, těsnění lze nainstalovat nesprávně.

Při nesprávné instalaci těsnění turbo nedosahuje parametrů, pro které bylo vyrobeno, protože nesprávná instalace brání vstupu výfukových plynů.



Nesprávný způsob



Nesprávný způsob

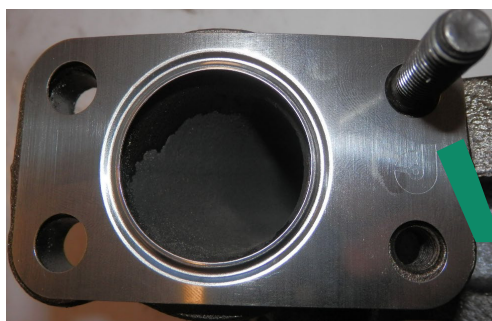

Správný způsob

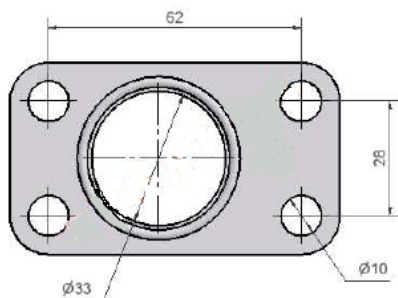

Kvóty těsnění

FIȘĂ TEHNICĂ 2009076

Vă rugăm să acordați o atenție deosebită atunci când poziționați garnitura dintre turbo și colectorul de evacuare. După cum puteți vedea în fotografiile de mai jos, există un mod greșit de poziționare a garniturii. Poziționarea necorespunzătoare a garniturii împiedică turbo să funcționeze în parametrii pentru care a fost proiectat, deoarece aceasta împiedică intrarea gazelor de eșapament.

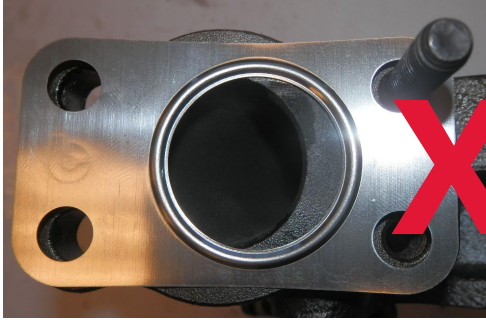

Greșit



Greșit



Corect

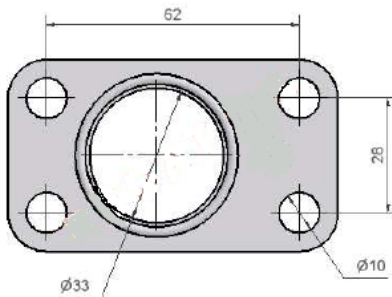

Dimensiunile garniturii de etanșare

MŰSZAKI ADATLAP 2009076

A turbó és a kipufogócső közötti tömítés elhelyezésekor különös figyelmet kell fordítani. Amint az alábbi képeken látható, a tömítés helyzete nem megfelelő. A tömítés helytelen elhelyezése megakadályozza, hogy a turbó azokkal a paraméterekkel működjön, amelyekre tervezték, mivel ez akadályozza a kipufogógázok bejutását.



Téves



Téves

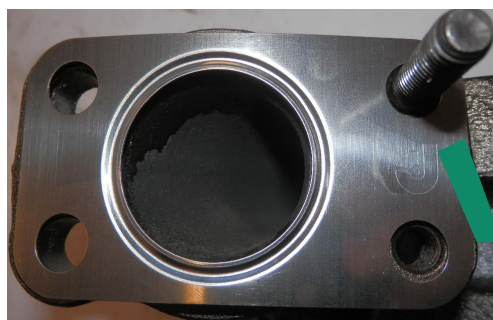

Helyes

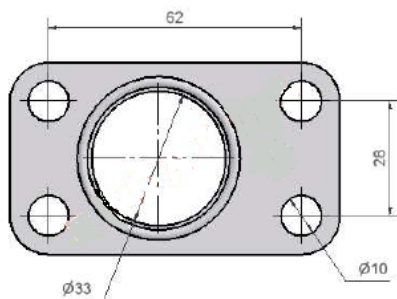

A tömítés méretei

TEHNIČNI LIST 2009076

Pri nameščanju tesnila med turbino in izpušnim kolektorjem bodite posebej pozorni. Kot lahko vidite na spodnjih fotografijah, obstaja napačen način namestitve tesnila.

Zaradi nepravilne namestitve tesnila turbo ne more delovati v skladu s parametri, za katere je bil zasnovan, saj ovira vstop izpušnih plinov.



Napačno



Napačno

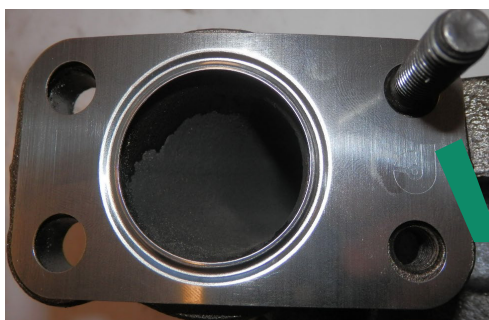

Pravilno

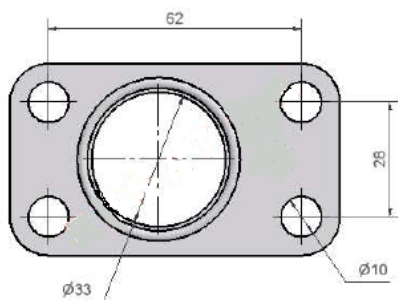

Dimenzije tesnila

Further information



You can find more information in our trouble shooting guidelines online.